



Intercom Installation Guide



Support: (800) 398-4416, ext. 2 (Mon-Fri, 6am-10pm EST)

Email: support@butterflymx.com

This ButterflyMX video intercom installation guide walks certified installers through the process of installing the ButterflyMX intercom. It lists all of the parts that come in the ButterflyMX package, all of the tools and components you need that aren't included, and a checklist for you to look over before you start the installation.

This guide also explains each step of the installation process. For each step, we go over the parts you'll be working with and what you need to know before you start.

For support questions or issues contact:

Phone: **(800) 398-4416, ext. 2**

(Mon-Fri, 6am-10pm EST)

Email: support@butterflymx.com

Important note: All ButterflyMX hardware must be installed by a certified ButterflyMX installer. See the next page for more information about becoming a certified installer.

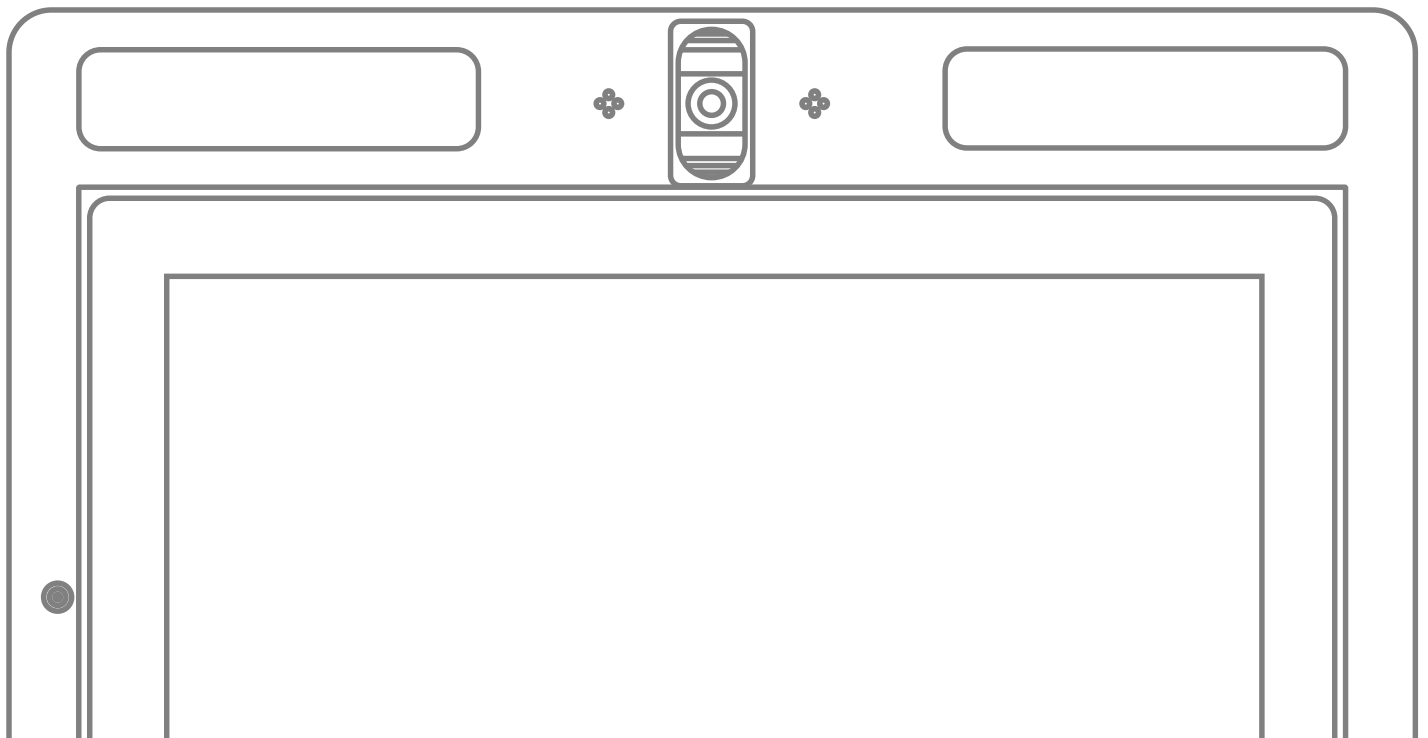

Before you start installing:

How to become a certified ButterflyMX installer.....4
Packing list of components included in the box.....5
Parts you'll need that aren't included.....6
Checklist of parts and equipment before you start the installation.....7

Installation steps:

Capture serial number.....8
Connect power.....10
Connect network.....12
Connect relay(s).....14
Mount intercom.....16
Activate & test intercom.....21

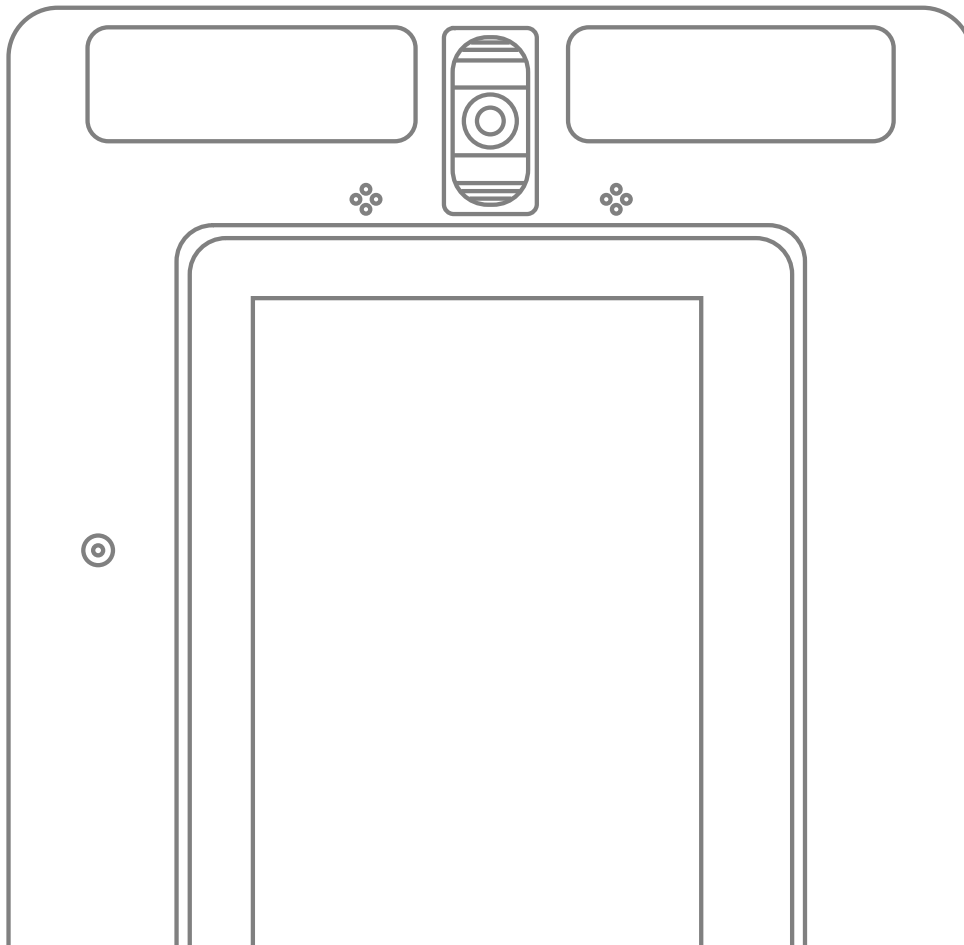

How to become a certified ButterflyMX installer

To qualify for dealer pricing and ensure you do not void our two-year hardware warranty, we require anyone installing our products to be certified.

The certification process is a free, online course and shouldn't take more than 30 minutes to complete. Once certified, we may also provide you with free installation referrals.

Scan the QR code below or visit butterflymx.com/cert/ to get certified now.



Packing list

Smart video intercom

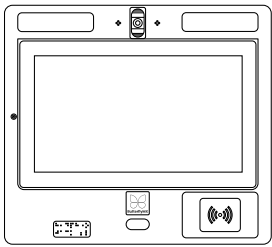

11.6" surface

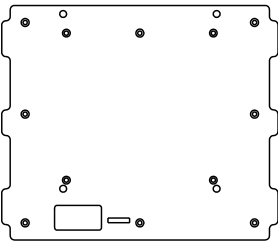

Video intercom mounting plate
(for surface intercoms only)

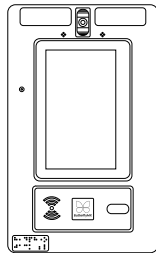

7" surface

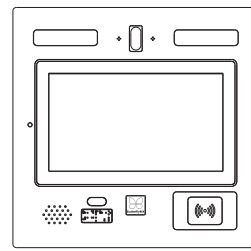
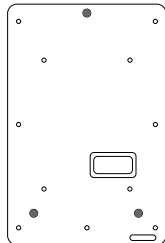

11.6" recessed

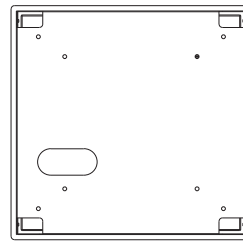

Video intercom mounting back box
(for recessed intercoms only)

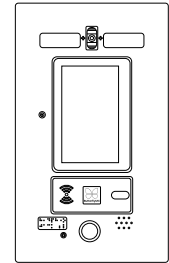

7" recessed

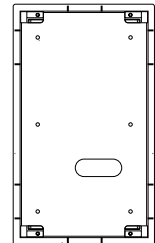

Power supply

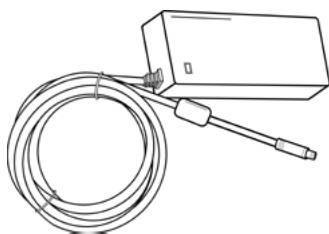

Power cable

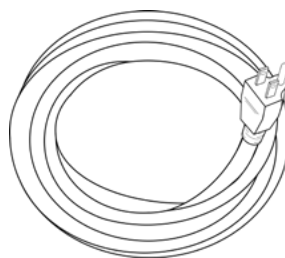

Video intercom keys



What's NOT in the box, but is required

Uninterrupted power supply (UPS)

Not including a UPS in the installation voids our video intercom's warranty.

- Required for power conditioning to protect device from voltage surges and drops.
- ButterflyMX minimum requirements: 600VA / 300W

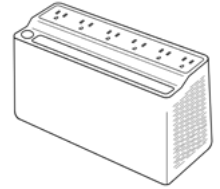

Cat cable (Cat 5e/6/6A only)

- Cat 5e/6/6A cable required.
- Length varies based on distance from intercom to router.
- If distance is between 300 ft and 500 ft, a network switch is needed.
- No more than 250 ft to network switch & 250 ft to router.

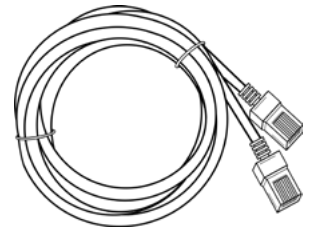

Additional low voltage cable

Length and gauge vary based on distance from intercom to outlet.

- 0 - 10 ft: use power adapter that is included & always install UPS.
- 10 - 50 ft: 18 AWG
- 50 - 100 ft: 16 AWG
- 100 - 180 ft: 14 AWG
- 180 - 300 ft: 12 AWG

If run length exceeds 200 ft, consider using a junction box.

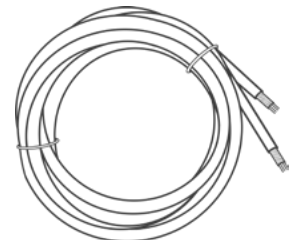

Isolation Relay (No ACS only)

Only required when no access control system (ACS) is present.

- Circuit that powers the lock needs to be separated (isolated) from the circuit that powers the relay.
- Requires Diodes (for DC locks) or Resistors (for AC locks)
- Needed to prevent inductive kickback.
- ButterflyMX recommendation for DC locks: 1N4001 & up
- ButterflyMX recommendation for AC locks: 470k ohms

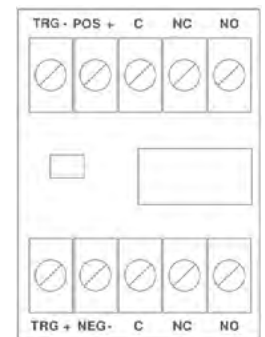

Before starting the installation

Please ensure you have all the required parts and equipment prior to installation. Don't hesitate to contact us if you need assistance.

Please contact ButterflyMX support at support@butterflymx.com if you have any questions or concerns related to installing the video intercom that are not addressed in this guide. You may also call **(800) 398-4416, ext. 2.**

When you're preparing tools and equipment, keep these requirements in mind:

- Correct extension cable gauge for power.
- UPS device is required for all video intercoms.
- An isolation relay is required for direct control where no ACS is present.
- Correct length for Cat 5e/6/6A cable.
- Correct mounting hardware if needed.

During installation, keep these requirements in mind:

- Never use AC to power the video intercom.
- Provide room behind the mounting location for excess wiring.
- Never introduce two power sources for a lock release in parallel.
- Some installations will require customized housing, especially retrofits.
- All recessed installations require proper silicone sealant.

Step 1: Capture serial number

What you'll need to capture the serial number:

- Video intercom
- Smartphone (not included)

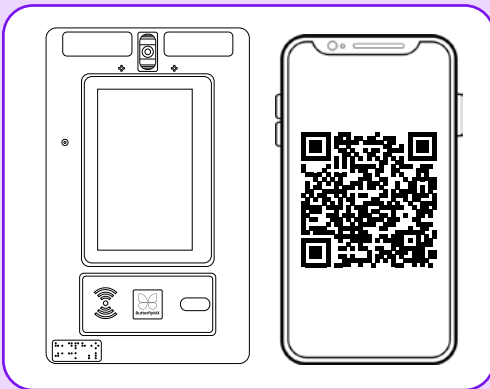

If you do not have access to a smartphone, locate and record the serial number on the label. You will need this to activate the intercom.

What you need to know before you begin capturing the serial number:

- You'll need to provide the serial number when you activate the video intercom by calling ButterflyMX.

Instructions for capturing the serial number:

1. Remove the video intercom from its shipping container.
2. Open the interior box and remove the protective foam insert.



3. Remove the video intercom from the foam housing and protective sleeve.
4. Note the keyhole cover on the bottom of the intercom.
5. Gently remove the keyhole cover — be careful not to damage the intercom housing.

Step 1: Capture serial number (continued)

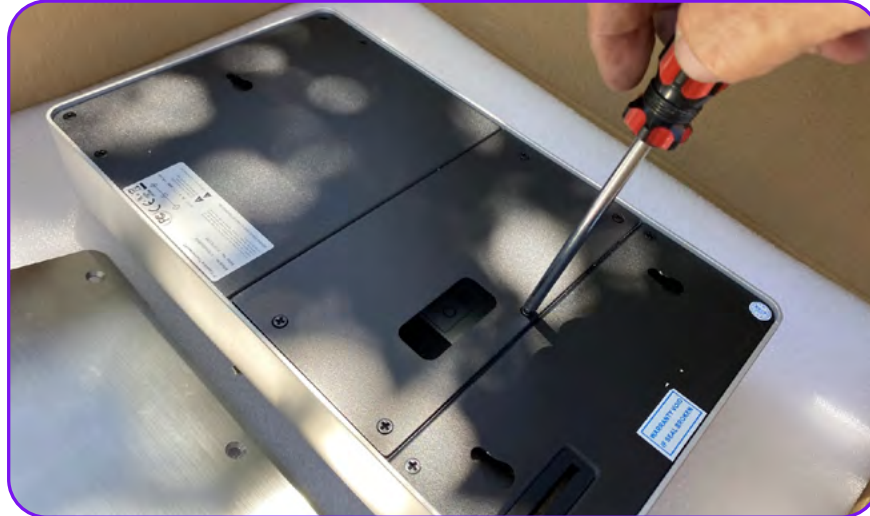

6. Use the video intercom keys provided to unlock the latch and remove the backplate.
7. Open the camera app on your smartphone and scan QR code on the back of the intercom.
8. Click the link generated by the QR code and enter required information.



ButterflyMX
www.butterflymx.com
support@butterflymx.com
Model No.: FT07SN4200BMX



Voltage Input: 24V
Max Current: 4000 mA
Manufactured exclusively for ButterflyMX by Faytech
Made in China





Product Name:
7" Capacitive Touchscreen PC

NAV Number:
3030503287

Article Number:
FT07SN4200BMX

Serial Number:
07S22N0899

MAC Address:
4C:93:45:86:78

 To reduce risk of electric shock, do not remove cover of back. No user serviceable parts inside.

 Pour réduire le risque de choc électrique, ne pas retirer le couvercle de l'arrière. Aucune pièce réparable par l'utilisateur à l'intérieur.

 Refer servicing to qualified personnel. Confiez l'entretien à un personnel qualifié.

This device complies with part 15 of the FCC rules. Operation is subject to the following two conditions: (1) this device may not cause harmful interference. And (2) this device must accept any interference received, including interference that may cause undesired operation.

Step 2: Connect power

To view a video walkthrough of power cable splicing, scan this QR code or visit butterflymx.com/installer/videos



What you'll need to connect power:

- Video intercom
- Power supply
- UPS (not included)
- Additional low-voltage cable if needed (not included)

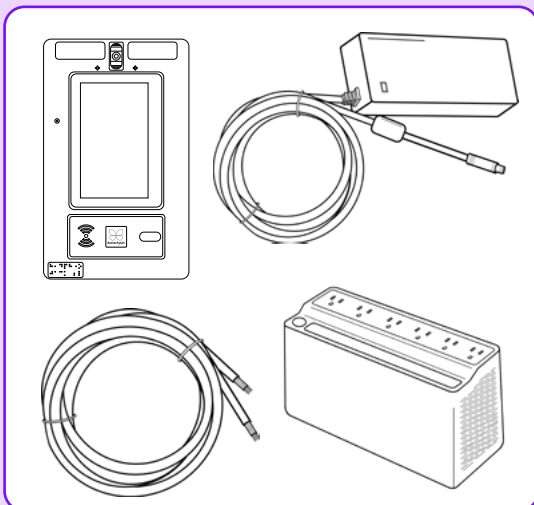

What you need to know before you begin connecting the power:

- Included power supply is 10 ft long.
- If the distance between the outlet and video intercom is more than 10 ft, you will need to splice the power cable to add additional cable (in instruction 5 below).
- UPS is required for installation.
- Recommended device: APC UPS Battery Backup and Surge Protector, 600VA BE600M1 Back-UPS
- Length and gauge vary based on distance from intercom to power source.
 - 0 - 10 ft use the power adapter that is included & always install UPS.
 - 10 - 50 ft requires 18 AWG.
 - 50 - 100 ft requires 16 AWG.
 - 100 - 180 ft requires 14 AWG.
 - 180 - 300 ft requires 12 AWG.
- If run length exceeds 200 ft, consider using a junction box.

Step 2: Connect power (continued)

Instructions for connecting the power:

1. Connect power adapter to intercom.
2. Connect intercom power supply to UPS.
3. Connect UPS to the power source.

If you need to run additional low voltage cable from the intercom to the power adapter, follow these steps:

4. Stretch the cable with the barrel connector and fold it around the middle.
5. Strip the outer sheath.
6. Separate the outer conductor from the inner conductor.
7. Twist the outer conductor into itself to make a single unsheathed cable.
8. Unsheathe the inner conductor.
9. Splice the outer conductor.
10. Place a dolphin or cap on the splice.
11. Repeat steps 6 and 7 with the inner conductor.
12. Use a multimeter to test the splice.

Step 3: Connect network

What you'll need to connect the network:

- Video intercom
- Cat 5e/6/6A cable (not included)

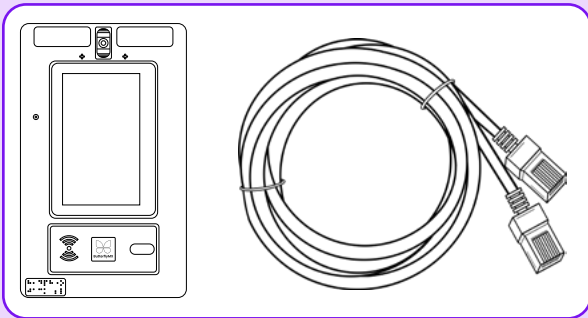

- Network should have at least 2 MB/s upload and download speed.
- Verify that the Cat cable has no splices.
- Locate router and verify internet access.
- If distance is between 300 ft and 500 ft, a network switch is needed.
 - No more than 250 ft to network switch & 250 ft to router.

What you need to know before you begin connecting the network:

- Ensure that intercom is powered.
- Depending on the installation environment, you may choose to connect the relays before connecting the intercom to the network.
- Cat 5e/6/6A cable required.
- Ensure your cable is the proper length.
- The intercom should be on a dedicated network for optimal performance.

Step 3: Connect network (continued)

Instructions for connecting the network:



1. Connect Cat cable to one available port on the intercom.

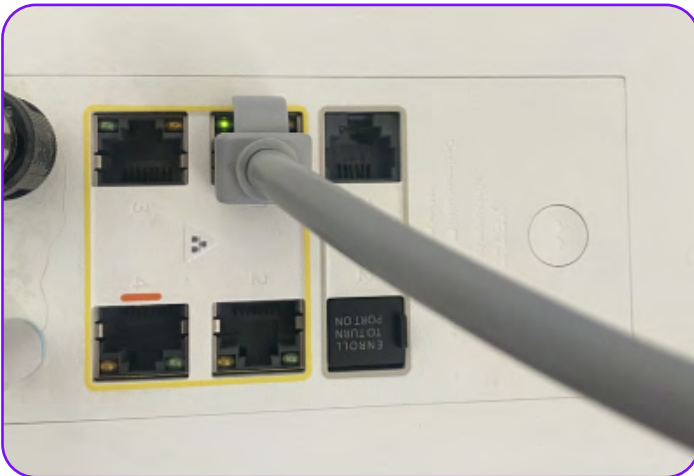

2. Connect other end of Cat cable to a dedicated router.

Step 4: Connect relay(s)

To view the Alternating Current (AC) and Direct Current (DC) wiring guides, scan this QR code or visit butterflymx.com/installer/



What you'll need to connect the relay(s):

- Video intercom
- Isolation relay (not included)
- Multimeter (not included)

What you need to know before you begin connecting the relay(s):

- When no access control system (ACS) is present, an isolation relay is required to protect the device from inductive kickback.
- The circuit that powers the lock needs to be isolated from the circuit that powers the relay.
- The intercom requires diodes (for DC locks) or resistors (for AC locks).
- When an ACS is present, connect the wired door directly to the request-to-exit (REX) device.

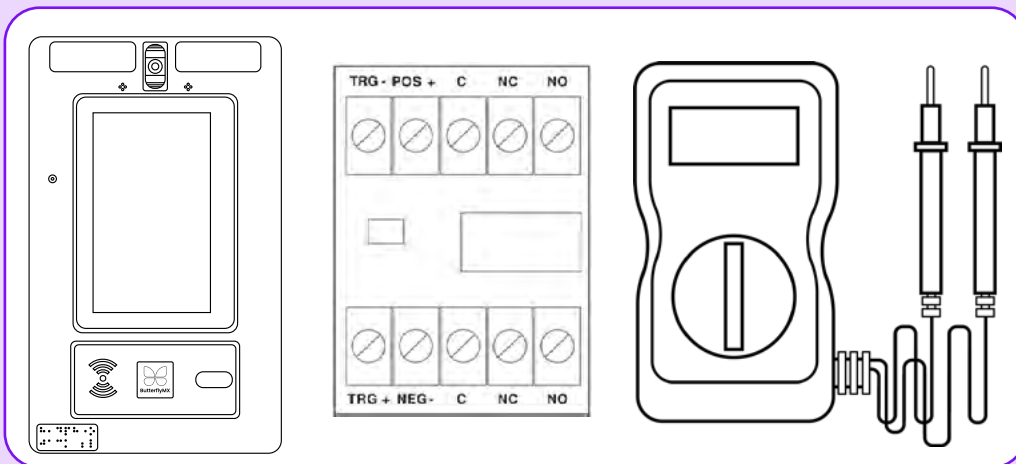

Instructions to connect the relay(s):

1. Determine whether an access control system (ACS) is present and it can receive inputs.
 - a. **If an ACS is not present** or it **cannot accept inputs**, installing an isolation relay is required. Skip to step 2.
 - b. **If an ACS is present**, connect the ACS directly to the intercom and skip the remaining steps of this section.
 - c. Please follow the documentation of the existing ACS to know how to configure the ACS inputs properly.
 - d. Repeat this step for each separate relay you are connecting to the video intercom.
 - e. Test the entire system, from activating the video intercom to unlocking the strike lock.
2. For a single relay to a single or simultaneous lock, refer to our isolation relay guide using the QR code above. We use the Altronix RB-5 relay in the example, but any equivalent low-voltage relay will work.
 - a. Voltage to the intercom cannot be alternating current (AC) at any voltage.
 - b. Maximum direct current is 12V at 2 amps.
3. If there are multiple locks, or if locks need to operate separately, consider a multi-relay board instead of a single-relay board and a power distribution board instead of individual power adapters.
4. Install a diode if DC power or resistor if AC power. Each lock needs a diode or resistor to prevent kickback voltage.
5. Test the entire system, from activating the video intercom to unlocking the strike lock.



Step 5: Mount the video intercom

First, identify your intercom:

7" Surface



11.6" Surface



7" recessed

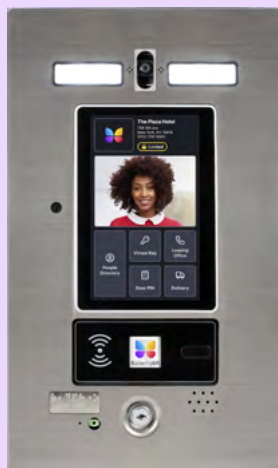

11.6" recessed



Mounting the 7" or 11.6" surface intercom

To view video walkthroughs of installing the backplate and mounting the 7" or 11.6" surface intercom, scan this QR code or visit butterflymx.com/resources/installers/videos/



What you'll need to mount the 7" or 11.6" surface video intercom:

- Video intercom
- Mounting backplate
- Custom backplate*

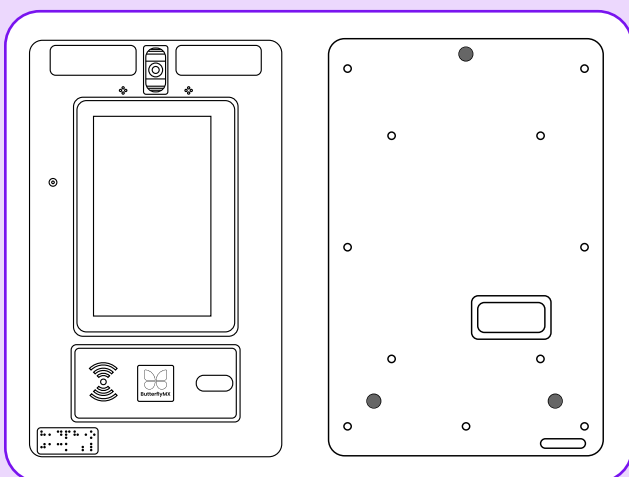

What you need to know before you begin mounting the 7" or 11.6" surface video intercom:

- Please examine the appropriate intercom cut sheets to familiarize yourself with the device.
- Some installations will require customized housing, especially retrofits.
- If you have any questions or issues with mounting the intercom, please contact ButterflyMX support at support@butterflymx.com

Instructions for mounting the 7" or 11.6" surface video intercom:

1. Remove the mounting backplate that is attached to the back of the intercom.
2. Pull all the cables through the supplied mounting backplate.
3. Anchor mounting backplate onto the surface where the intercom will be located.

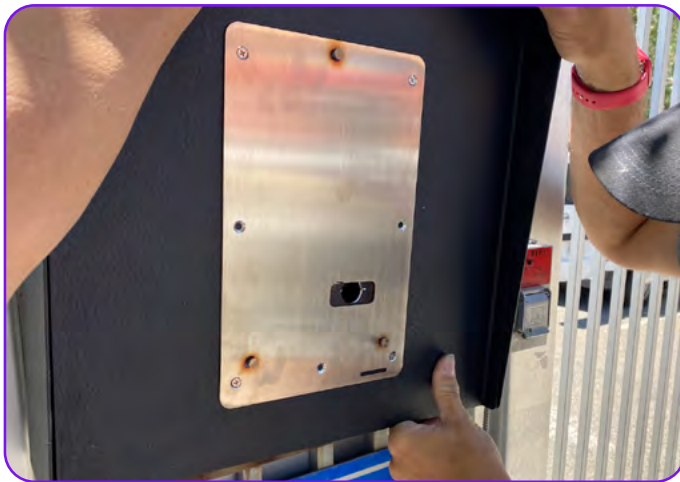

4. Connect necessary power, network, and relay wires to the video intercom.



5. Mount intercom onto the mounting backplate attached to the surface.
6. Insert panel key and lock intercom onto mounting backplate.



Mounting the 7" or 11.6" recessed intercom

To view a video walkthrough of mounting a recessed intercom, scan this QR code or visit butterflymx.com/resources/installers/videos/



What you'll need to mount the 7" or 11.6" recessed video intercom:

- Video intercom with attached faceplate
- Mounting backbox

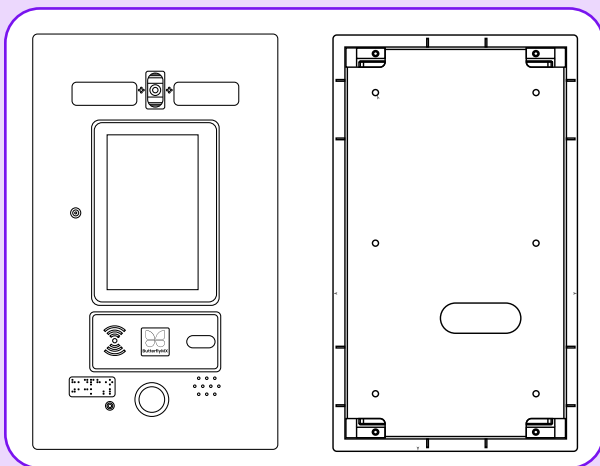

What you need to know before you begin mounting the 7" or 11.6" recessed video intercom:

- Please examine the appropriate intercom cut sheets to familiarize yourself with the device.
- Ensure at least 3" of depth where intercom will be located.
- Backbox should be at least 1/16 of an inch out from the wall.
- If you have any questions or issues with mounting the intercom, please contact ButterflyMX support at support@butterflymx.com

Instructions for mounting the 7" or 11.6" recessed video intercom:

1. Using the panel key, unlock and remove the mounting backbox that is attached to the back of the video intercom.
2. **For the 7" intercom only:** The 7" recessed intercom has additional screws that need to be removed to remove the backbox. First, remove the faceplate by unlocking it with the intercom key and then remove the screws on the outer edge to remove the backbox from the intercom.
3. Pull all the cables through the supplied mounting backbox.
4. Anchor mount the backbox onto the surface where the intercom will be located.



5. Connect necessary power, network, and relay wires to the intercom.



6. Mount the video intercom onto the mounting backbox.
7. **For the 7" intercom only:** The 7" recessed intercom has additional screws that need to be screwed back into the mounting backbox. Place the faceplate back on the intercom.
8. Insert panel key and lock intercom onto mounting backbox.



Step 6: Activate and test the intercom

What you'll need to activate and test:

- Video intercom
- Smartphone (not included)

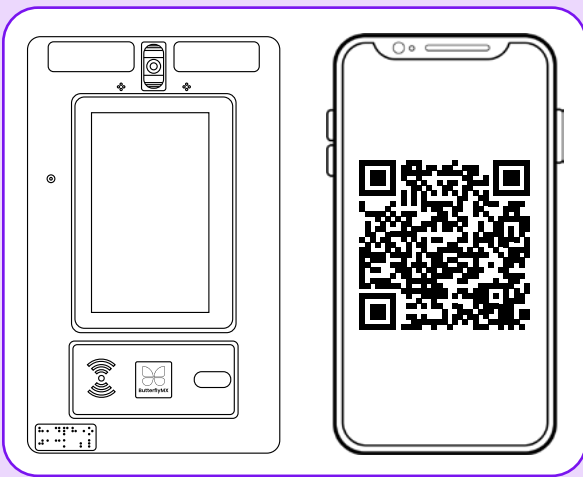

What you need to know before you begin activating and testing:

- The installer must work with the ButterflyMX support team while onsite in order to activate, configure, and test the video intercom.
- If you were not able to successfully scan the QR code and add the device to ButterflyMX, you'll need to supply the serial number on the back of the intercom.

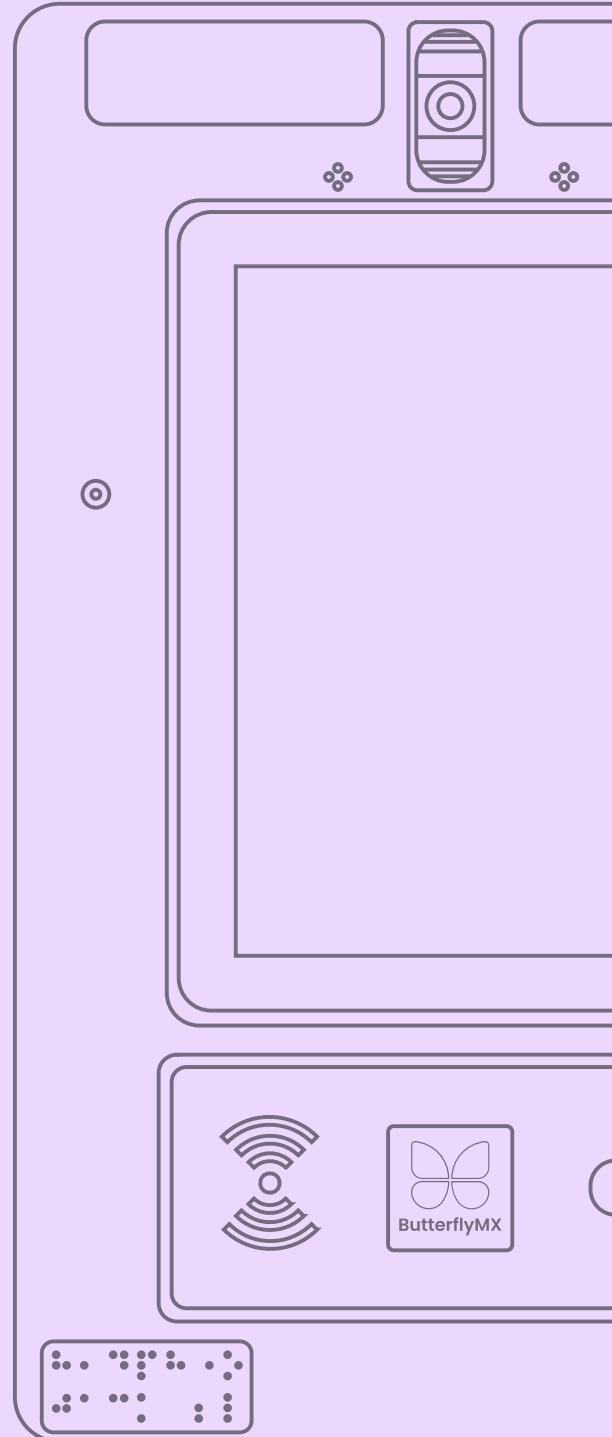

Instructions for activating and testing:

1. To activate the intercom, call ButterflyMX support at **(800) 398-4416, ext. 2**.
2. Give ButterflyMX support the intercom serial number, the address of the building, and the wiring specs.
3. ButterflyMX support will work with the installer to activate and configure the intercom.
4. ButterflyMX support will perform a test video call from the intercom and confirm that video, sound, and door lock(s) are functioning properly.

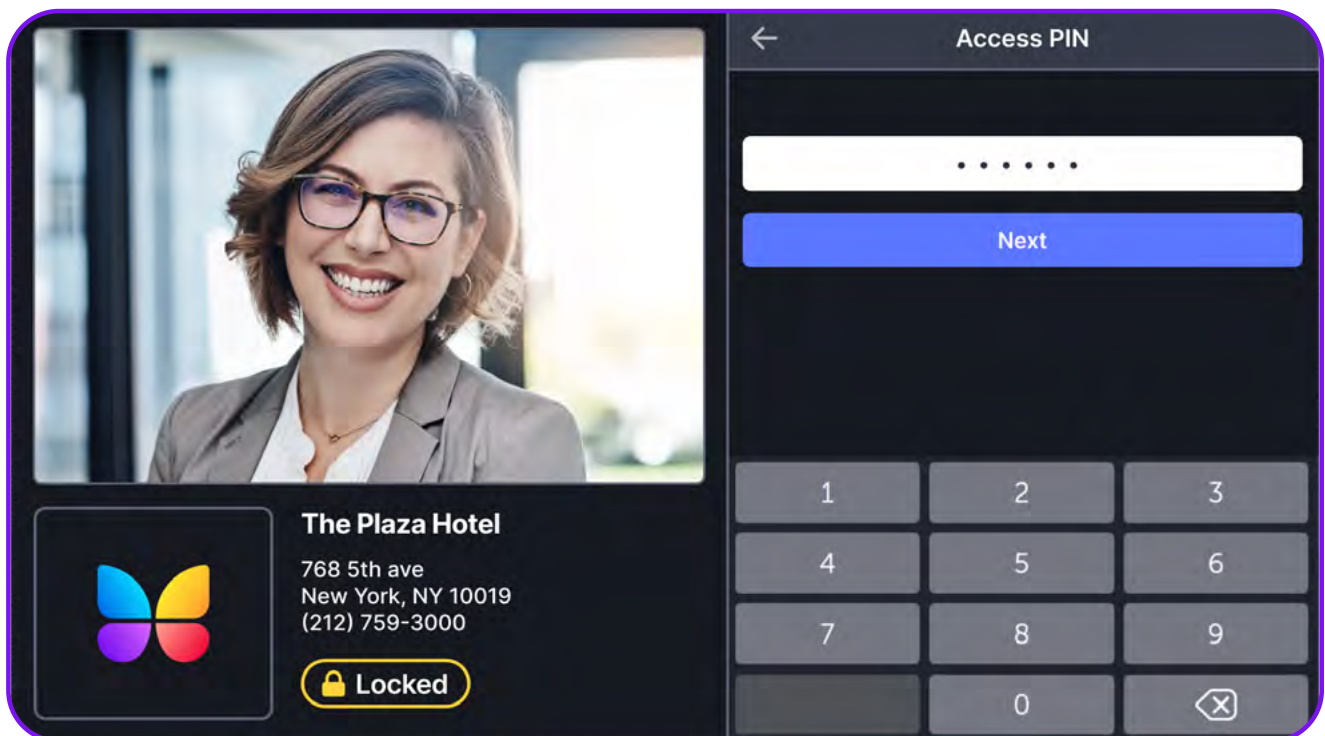

5. ButterflyMX support will supply a delivery code for the installer to test intercom functionality.
6. Notify the client that installation is complete and show that the ButterflyMX video intercom is functioning properly.